

**Canon**

# SELPHY CP800

COMPACT PHOTO PRINTER

## Printer User Guide



ENGLISH

- Make sure you read this guide, including the “Safety Precautions” section, before using the printer.
- Store this guide safely so that you can use it in the future.



CDI-E434

# Package Contents

Check if the following items are included in your printer package, using the  check boxes. If anything is missing, contact the retailer where you purchased the printer.

SELPHY Printer Unit

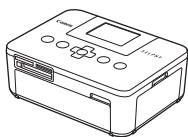

Compact Power Adapter  
CA-CP200 W

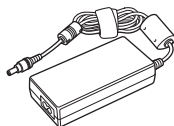

Power Cord

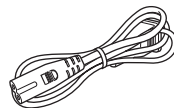

Paper Cassette (Postcard Size)  
PCP-CP300

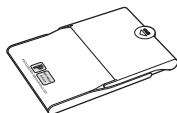

Paper Cassette (Card Size)\*  
PCC-CP300



CD-ROM:  
COMPACT PHOTO  
PRINTER Solution Disk



Printer User Guide (This Guide)



Support Guide



Warranty Card



\* Card size paper cassette may not be included depending on the region.

## Ink and Paper (Sold Separately)

Before using the printer, be sure to purchase a Color Ink Cassette/Paper Set separately.

Color Ink Cassette/Paper Set			Necessary Paper Cassette
Product Name	Paper Size	Number of Possible Prints	
Color Ink Cassette/Paper Set KP-36IP (Postcard)	Postcard Size	36	Paper Cassette PCP-CP300 (Included with SELPHY)
Color Ink Cassette/Paper Set KP-72IN (Photo Paper)		72	
Color Ink Cassette/Paper Set KP-108IN (Photo Paper)		108	
Color Ink Cassette/Paper Set KC-36IP	Card Size	36	Paper Cassette PCC-CP300
Color Ink Cassette/Label Set KC-18IF (Full-page labels)		18	
Color Ink Cassette/Label Set KC-18IL (8-label sheets)		18	

Some accessories may not be available depending on the region.

## Read This First

### Warning Against Copyright Infringement

The images printed with this product should be intended for personal use. Do not print images that infringe upon copyright laws without the prior permission of the copyright holder.



### Warranty Limitations

This product's warranty is only effective in the country of sale. If there is a problem with the printer while abroad, please return it to the country of sale before proceeding with a warranty claim to a Canon Customer Support Help Desk.

### LCD Monitor (Screen)

- The LCD monitor is produced with extremely high-precision manufacturing techniques. More than 99.99% of the pixels operate to specification. However, some pixels may occasionally misfire or appear as red or black dots. This has no effect on the printed image and does not constitute a malfunction.
- The LCD monitor may be covered with a thin plastic film for protection against scratches during shipment. If so, remove the film before using the printer.

## Conventions Used in this Guide

- This printer will be referred to as “SELPHY” or “printer”.
- The various types of memory cards that can be used in this printer are collectively referred to as “memory cards”.
- Icons are used in the text to represent SELPHY’s buttons. For details, refer to “Controls” (p. 6).
- Language that displays on the screen appears inside [ ] (square brackets).
-  : Things you should be careful about
-  : Supplemental information
- (p. XX) : Reference pages (“XX” stands for a page number)
- This guide assumes all functions are at their default settings.

## Table of Contents

Package Contents _____	2	Storing the Printed Photos _____	16
Ink and Paper (Sold Separately) _____	2	Cleaning Up After Printing _____	16
Read This First _____	3	Printing a Variety of Images _____	17
Conventions Used in this Guide _____	3	Printing From Your Computer _____	22
Safety Precautions _____	4	Installing and Starting the Software _____	23
Setting Up SELPHY _____	5	Using the Software to Print _____	25
Components Guide _____	6	Printing From Your Digital Camera _____	27
Information Displayed on the Screen _____	7	Printing Images Using Digital Camera Specified Settings (DPOF Print) _____	28
Getting Started _____	8	Using the Battery Pack _____	29
Setting the Display Language _____	11	Printing From Your Mobile Phone _____	30
Compatible Memory Cards and Memory Card Slots _____	12	Troubleshooting _____	31
Images That Can Be Printed _____	12	Specifications _____	33
Selecting and Printing Images _____	13	Handling Precautions _____	34
Printing All Images _____	15		

# Safety Precautions

- Before using the product, please ensure that you read the safety precautions described below. Always ensure that the product is used correctly.
- The safety precautions noted on the following pages are intended to prevent injuries to yourself and other persons, or damage to the equipment.
- Be sure to also check the guides included with any separately sold accessories you use.



## Warning

Denotes the possibility of serious injury or death.

- **Store this equipment out of the reach of children and infants.**

Mistakenly putting the power cord around a child's neck could result in asphyxiation.

- **Use only recommended power sources.**
- **Do not attempt to disassemble, alter or apply heat to the product.**
- **Avoid dropping or subjecting the product to severe impacts.**
- **To avoid the risk of injury, do not touch the interior of the printer if it has been dropped or otherwise damaged.**
- **Stop using the product immediately if it emits smoke, a strange smell, or otherwise behaves abnormally.**
- **Do not use organic solvents such as alcohol, benzene, or thinner to clean the equipment.**
- **Do not let the product come into contact with water (e.g. sea water) or other liquids.**
- **Do not allow liquids or foreign objects to enter the printer.**

This could result in electrical shock or fire.

If liquid comes into contact with the product, unplug it from the outlet and consult your retailer or a Canon Customer Support Help Desk.

- **Do not touch this printer or the power plug during thunderstorms.**

This could result in electrical shock or fire. Immediately stop using the equipment and distance yourself from it.

- **Unplug the power cord periodically and wipe away any dust and dirt that has collected on the plug, the exterior of the power outlet, and the surrounding area with a dry cloth.**
- **Do not handle the power cord with wet hands.**
- **Do not use the equipment in a manner that exceeds the rated capacity of the electrical outlet or wiring accessories. Do not use if the power cord or plug are damaged, or not fully plugged into the outlet.**
- **Do not allow dirt or metal objects (such as pins or keys) to contact the terminals or plug.**
- **Do not cut, damage, alter or place heavy items on the power cord.**

This could result in electrical shock or fire.

- **Do not play the supplied CD-ROM(s) in any CD player that does not support data CD-ROMs.**

Playing the CD-ROM(s) in an audio CD player (music player) could damage the speakers. It is also possible to suffer hearing loss from listening with headphones to the loud sounds of a CD-ROM played on a music CD player.



## Caution

Denotes the possibility of injury.

- **Do not stick any part of your hand into the printer interior.**
- **Be sure to place SELPHY safely so as to avoid tripping over the power cord.**

This could lead to injury or damage the printer.

- **Avoid using, placing or storing the printer in the following places.**

- Places subject to strong sunlight.
- Places subject to temperatures above 40 °C (104 °F).
- Humid or dusty areas.
- Places subject to strong vibrations.

These could result in electrical shock, burns, fire or other injuries.

High temperatures may cause deformation of the adapter or printer casing.

## Caution

Denotes the possibility of damage to the equipment.

- **Unplug the product from the power outlet when you are not using it.**
- **Do not place anything, such as cloth, on top of the printer while in use.**

Leaving the unit plugged in for a long period of time may cause it to overheat and become distorted, resulting in fire.

## Setting Up SELPHY

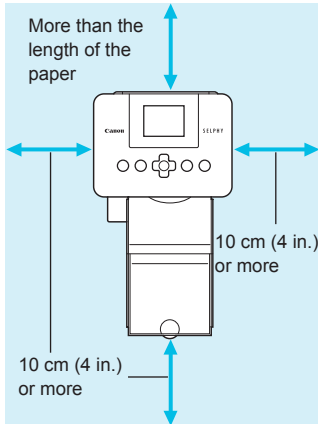

- Place SELPHY on a stable and even surface, such as a table. Never place it on an unstable or tilted surface.
- Keep SELPHY at least 1 m (3 ft.) from devices emitting electromagnetic waves or strong magnetic fields.
- Make sure there is at least 10 cm (4 in.) of free space around SELPHY.
- Since paper will pass in and out of SELPHY during printing, make sure the space behind the printer is greater than the length of the paper.



- Never place SELPHY close to motors or other devices that generate strong electromagnetic fields. This may damage the printer or cause it to malfunction.
- Do not place near a television or radio. This may cause the printer to malfunction.

# Components Guide

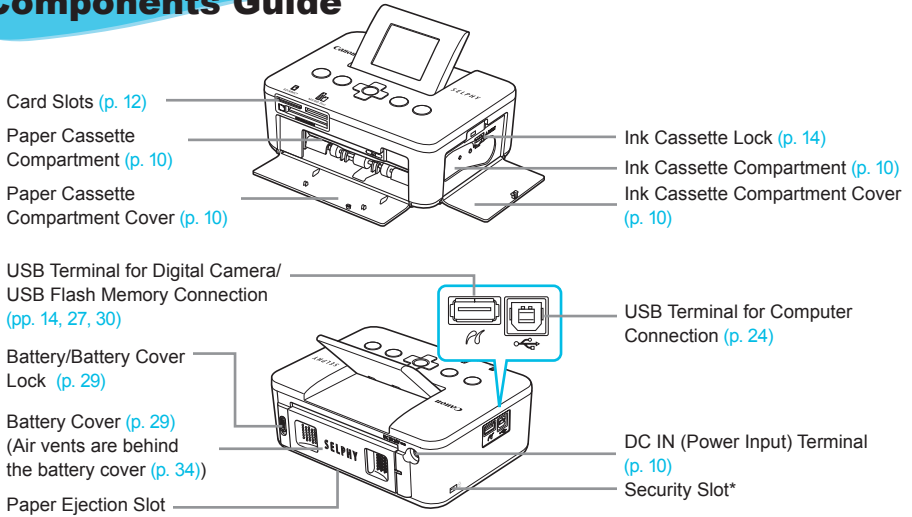

\* Security cables, such as a Kensington lock, can be attached to this slot.

## Controls

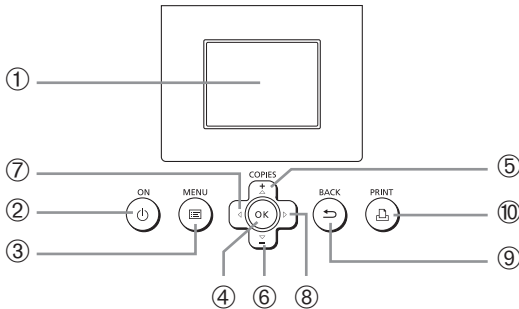

Icons Used in This Guide		Name	Function
①	—	Screen (LCD Monitor)	Displays images, settings screens, or error messages (p. 32).
②	⏻	Power Button	Turns SELPHY on or off (p. 11).
③	☰	Menu Button	Displays the menu screen (p. 11).
④	OK	OK Button	Sets the selected item.
⑤	▲	Up/+ Copies Button	Specifies number of copies, selects items to set.
⑥	▼	Down/- Copies Button	
⑦	◀	Left Button	Switches images, changes settings.
⑧	▶	Right Button	
⑨	↶	Back Button	Restores the previous screen (p. 7), cancels printing (p. 14).
⑩	🖨️	Print Button	Starts printing (p. 14).

# Information Displayed on the Screen

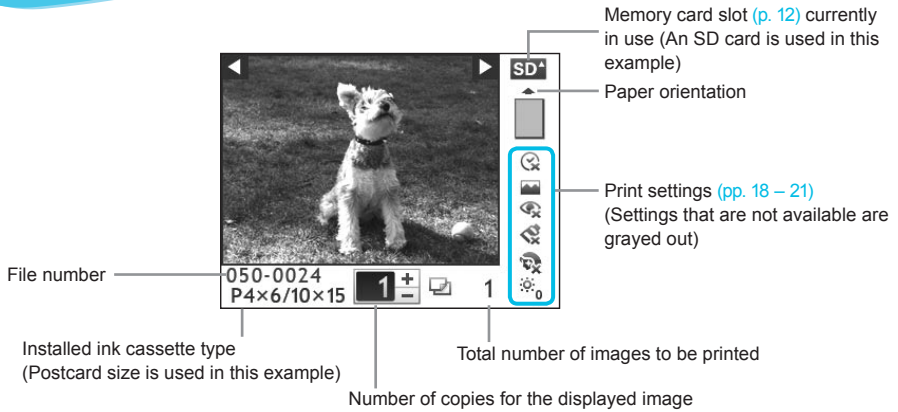

## Hiding Information Displayed on the Screen

You can hide the information displayed on the screen and view images at a larger size.

1

### Display the settings screen.

- Follow Steps 1 – 3 on p. 11.

2

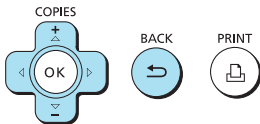

### Make the setting.

- Press the ▲▼ buttons to select [Info Display].
- Press the ◀▶ buttons to select [Off], then press the ↵ button to complete the setting.
- Pressing the ↵ button again will restore the image display screen.



- ▶ The image will display full screen, and a frame that indicates the printing area will appear.

# Getting Started

Preparations for printing images. A Postcard size Color Ink Cassette/Paper Set (sold separately) (p. 2) will be used as an example, however Color Ink Cassette/Paper Sets other than Postcard size may also be used in the same way to prepare for printing.

## Preparing the Ink Cassette

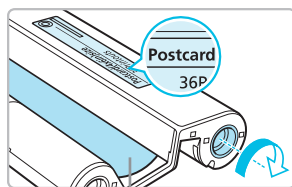

Ink sheet

### Check the ink cassette.

- Check that the paper size and the size shown on the color ink cassette (Card size, Postcard size etc.) match.
- Check that the ink sheet is taut with no slack. If the ink sheet is slack, push and turn the sprocket as shown in the illustration.
- If you overwind the ink sheet, it may not be possible to use all the paper for printing and the ink sheet may tear.



Do not touch or pull on the ink sheet. Do not touch the ink cassette with wet or sweaty hands. You may not be able to print if the ink sheet is damaged, dirty or wet.

## Preparing the Paper Cassette

1

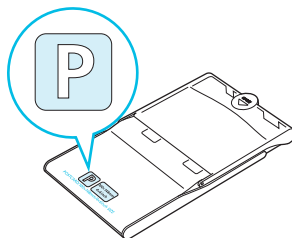

### Check the paper size.

- Check that the prepared ink cassette and the size shown on the paper cassette (Card size, Postcard size, etc.) match.

2

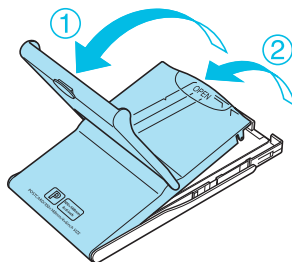

### Open the lid.

- There are two steps to open the lid. Open the outer lid (1) first, then open the inner lid (2).



3

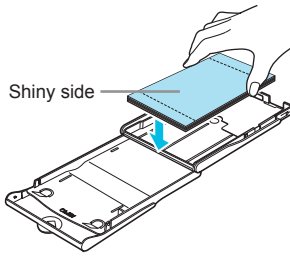

### Set the paper.

- Set the paper into the paper cassette that you prepared.
- You can place up to 18 sheets in the paper cassette. Inserting 19 or more sheets may damage the printer or cause malfunction.
- Hold the paper as shown in the illustration, with the shiny side facing up and put it into the paper cassette. Do not touch the print side (shiny side) of the paper with your fingers. This may prevent you from making clean prints.
- If a protective sheet is included with the paper, remove it and set the paper only into the cassette.
- When making Postcard size prints that have a section for pasting a stamp, insert the paper so that the stamp section is facing the direction shown in the illustration.

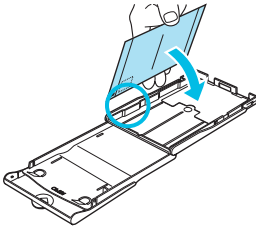

4

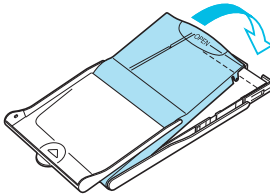

### Close the lid.

- Close the inner lid until it clicks into place. Leave the outer lid open during printing.



- Use only dedicated paper for use in SELPHY CP series printers included in the genuine Canon brand Color Ink Cassette/Paper Sets. Regular printing paper, regular postcards, or dedicated paper for SELPHY ES series printers cannot be used.
- Never do the following, as it may result in failure or cause the printer to malfunction:
  - reverse the paper (the shiny side is the print side)
  - bend or separate the paper at the perforations before printing
  - use label sheets that have begun to peel or label sheets with portions peeled back
  - write on a sheet before printing
  - print on already printed paper
  - reuse a spent ink cassette
- Do not touch the springs of the paper cassette. If the springs are bent or deformed, paper will not feed correctly into SELPHY.
- Do not touch or scratch the print surface (shiny side), or touch the paper with wet hands. If the print surface becomes dirty or wet, you will not be able to make clean prints.

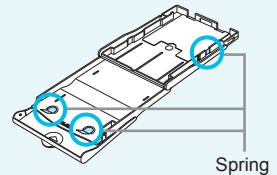

## Inserting the Ink and Paper Cassettes



1

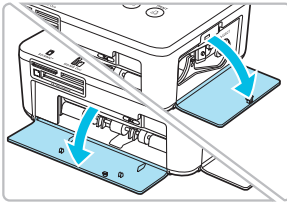

### Open the covers.

- Open the covers for the ink cassette and paper cassette compartments.

2

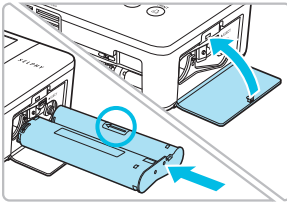

### Insert the ink cassette.

- Insert the ink cassette into the printer in the direction indicated by the arrow on the cassette until it clicks and locks into place.
- Close the ink cassette compartment cover.

3

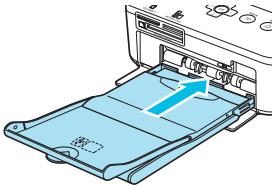

### Insert the paper cassette.

- Make sure that the outer lid is open (p. 8) and insert the paper cassette all the way into the compartment.

## Connecting SELPHY



1

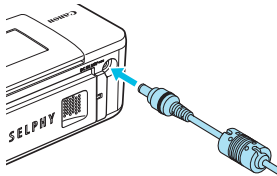

### Plug the adapter cord into SELPHY.

- Fully insert the adapter plug into SELPHY.

2

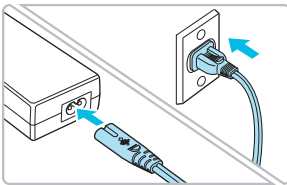

### Connect the power cord.

- Connect the power cord to the compact power adapter, then plug the other end into a power outlet.



# Setting the Display Language

You can change the language displayed in the LCD monitor menus and messages.

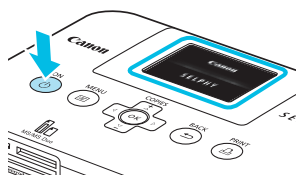
1



## Turn on SELPHY.

- Press and hold the  button until the screen shown at the left displays.
- To turn the power off, press and hold the  button again until the displayed screen changes or turns off.

2

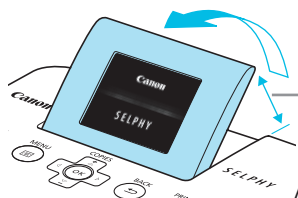



## Adjust the screen for ease of viewing.

- Raise the LCD monitor and adjust until the screen is easily visible.
- Do not raise the LCD monitor more than 45° as this may result in damage or malfunction.

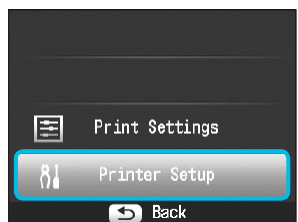
3



## Display the settings screen.

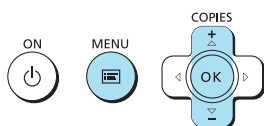

- Press the  button.
- Press the   buttons to select [Printer Setup], then press the **OK** button.



4



## Display the language settings screen.



- Press the   buttons to select [Language].
- Press the **OK** button.

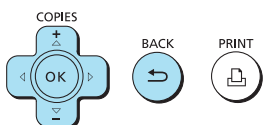

5





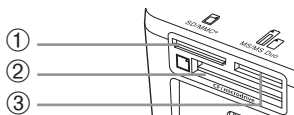

## Select a language.

- Press the   buttons to select a language, then press the **OK** button.
- Pressing the  button twice will restore the screen in Step 1.

# Compatible Memory Cards and Memory Card Slots



Card Slots	Memory Cards That Can be Used Without an Adapter	Memory Cards That Require an Adapter (commercially available)
①  SD/MMC+	<ul style="list-style-type: none"> <li>● SD Memory Card</li> <li>● SDHC Memory Card</li> <li>● SDXC Memory Card </li> <li>● MultiMediaCard</li> <li>● MMCplus Card</li> <li>● HC MMCplus Card</li> </ul>	<ul style="list-style-type: none"> <li>● miniSD Memory Card</li> <li>● miniSDHC Memory Card </li> <li>● microSD Memory Card</li> <li>● microSDHC Memory Card</li> <li>● microSDXC Memory Card</li> <li>● RS-MMC Card *<sup>1</sup></li> <li>● MMCmobile Card</li> <li>● MMCmicro Card</li> </ul>
②  CF/microdrive	<ul style="list-style-type: none"> <li>● CF (CompactFlash) Card</li> <li>● Microdrive</li> </ul>	<ul style="list-style-type: none"> <li>● xD-Picture Card*<sup>2</sup></li> </ul>
③  MS/MS Duo	<ul style="list-style-type: none"> <li>● Memory Stick</li> <li>● Memory Stick PRO</li> <li>● Memory Stick Duo</li> <li>● Memory Stick PRO Duo</li> </ul>	<ul style="list-style-type: none"> <li>● Memory Stick micro</li> </ul>

\*<sup>1</sup> "RS-MMC" is an abbreviation of "Reduced-Size MultiMediaCard".

\*<sup>2</sup> Purchase the CompactFlash Card Adapter for xD-Picture Card.



- For memory cards that require an adapter, be sure to first insert the memory card into the adapter before inserting into the appropriate card slot. If you insert the memory card into a card slot without using an adapter, you may not be able to remove the memory card from the printer.
- Use a memory card formatted in the device used for taking the images. A memory card formatted on a computer may not be recognized.



Refer to the user guide included with your memory card and adapter for handling instructions.

## About USB Flash Memory



You can print images on a commercially available USB flash memory by connecting it to SELPHY (p. 14).

## Images That Can Be Printed

JPEG images conforming to the Exif standard can be printed with SELPHY.



Irregularly sized images, or images that have been edited on a computer may not display or print properly.



# Selecting and Printing Images

You can select an image and specify the number of copies for printing. In this section, an SD memory card will be used as an example, but you can print from other memory cards using the same steps.

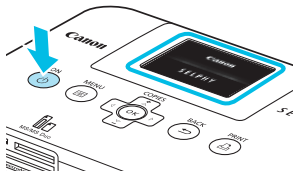
1



## Turn on SELPHY.

- Press and hold the  button until the screen shown at the left displays.
- To turn the power off, press and hold the  button again until the displayed screen changes or turns off.

2

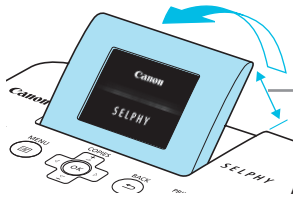

## Adjust the screen for ease of viewing.

- Raise the LCD monitor and adjust until the screen is easily visible.
- Do not raise the LCD monitor more than 45° as this may result in damage or malfunction.

3

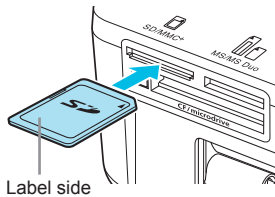



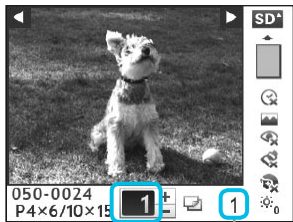

## Insert a single memory card into the slot.

- Insert a memory card fully into the appropriate slot.
- ▶ The screen in Step 4 below (image display screen) (p. 7) will display.

4



## Select an image.





- Press the   buttons to select an image to print.
- If you press and hold one of the   buttons, the display jumps by 5 images.

5

Number of copies for the displayed image

Total number of images to be printed

## Select the number of copies.



- Press the   buttons to select the number of copies.
- If you press and hold one of the   buttons, the number increases or decreases by 5 copies.
- You can select up to 99 copies per image.
- To print another image, repeat Steps 4 and 5.

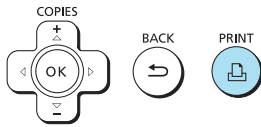

6



## Print.

- Press the  button to start printing.
- During printing, the paper will pass in and out from the back of SELPHY several times. Do not touch the paper until printing has finished and the printed sheets collect on the print output tray (on the outer lid of the paper cassette).
- Do not let 19 or more printed sheets collect on the print output tray.
- To cancel printing, press the  button.

7

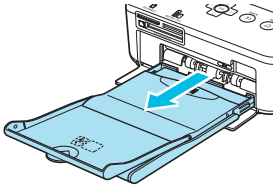

## Insert the paper.

- When the paper is depleted, remove the paper cassette from SELPHY.
- Refill the paper cassette with new paper (p. 8), and reinsert the cassette into SELPHY (p. 10).

8

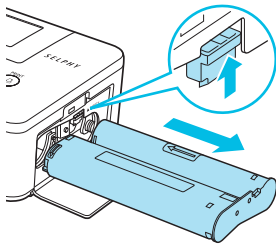

## Change the ink cassette.

- When the color ink is depleted, open the ink cassette compartment cover and move the lock as shown in the illustration. The ink cassette will be ejected.
- Insert a new ink cassette (pp. 8, 10).



Never pull out the paper cassette, open the ink cassette compartment cover, or remove the memory card while you can hear the printer's operation sounds immediately after turning on the printer, or during printing. This may cause the printer to malfunction.



- It may take some time before images display if the memory card contains a large number of images.
- When the total number of copies for printing is set to 0 and you press the  button, the currently displayed image will print once.
- If the [Start DPOF printing] screen displays, refer to "Printing Images Using Digital Camera Specified Settings (DPOF Print)" (p. 28).

## Printing From USB Flash Memory

Just like images on memory cards, images on commercially available USB flash memory can also be printed.

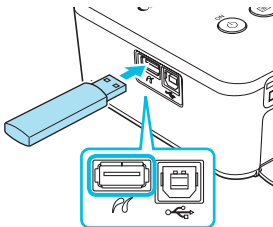

## Insert a USB flash memory.

- Insert a USB flash memory as shown.
- All further steps are the same as those used for printing images from memory cards (pp. 13 – 14).



- Depending on the brand of USB flash memory used, it may be difficult to insert or remove, and it may not operate properly.
- Refer to the user guide included with your USB flash memory for operating instructions.

# Printing All Images

You can print all images on a memory card at once.

1

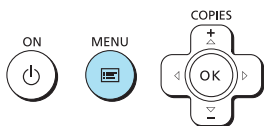



## Display the menu.

- Press the  button.

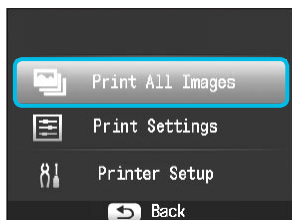
2



## Display the settings screen.

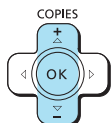

- Press the   buttons to select [Print All Images], then press the **OK** button.

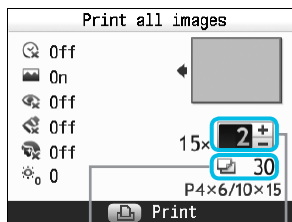

3



## Select the number of copies.

- Press the   buttons to set the number of copies.
- You can select up to 99 copies per image. If there are more than 1000 images on the card, only 999 copies will be printed in order of the most recent by shooting date.



Number of sheets required      Number of copies

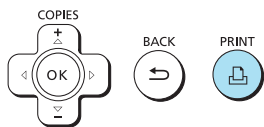

4



## Print.

- Press the  button to start printing.
- To cancel printing, press the  button.

## Storing the Printed Photos

- When both edges of a print have perforations, you can remove the edges by bending them.
- Use an oil-based pen to write on prints.
- To prevent discoloration, do not store prints in places subject to temperatures of over 40 °C (104 °F), humid or dusty places, or in direct sunlight.
- Avoid the following actions as they may result in color change, color fading or color bleeding: Sticking any type of adhesive tape on a print surface, allowing print surfaces to come into contact with vinyl or plastic, applying alcohol or other volatile solvents to a print surface, or leaving the print surface tightly pressed against other surfaces or objects for prolonged periods.
- If you wish to mount prints in an album, select an album with photo covers made of nylon, polypropylene or cellophane.

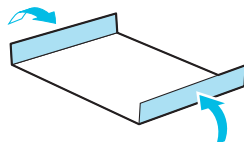

Color may change over time or depending on storage conditions. Canon assumes no liability for color changes.

## Cleaning Up After Printing

After you finish printing, follow the steps below to clean up and store SELPHY.

- Turn off SELPHY (p. 11), then remove the memory card or USB flash memory.
- Lower the screen (LCD monitor) completely for storage.
- Unplug the power cord from the power outlet and disconnect the adapter plug from SELPHY.
- If the compact power adapter is hot, wait until it has cooled down before you store it.
- Remove the paper cassette and close the paper cassette compartment cover. Keep the remaining paper inside the cassette and store the cassette in a dark place free from dust.
- Keep the ink cassette inside SELPHY.
- Store SELPHY horizontally, in a dark place free from dust.



- When not using SELPHY, make sure to store the printer with the screen (LCD monitor) completely lowered.
- If dust enters SELPHY and sticks to the paper or color ink, print quality will deteriorate.



- When you have more than one ink cassette, keep one inside SELPHY, and put the other inside the original packaging or a bag to protect it from dust, and store it in a dark place.
- When storing new paper and ink cassettes, leave them in unopened packages, and keep them in a dark place.



# Printing a Variety of Images



You can use various printing features, such as imprinting the shooting date or adjusting the color of an image. You do not need to repeat the settings for each image because once the settings are made, they are applied for all images.

## Making Settings

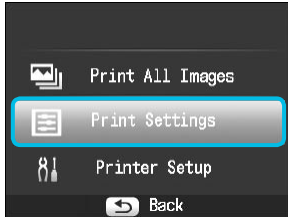
1



### Display the settings screen.



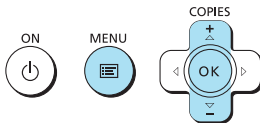

- Press the  button.
- Press the  buttons to select [Print Settings], then press the **OK** button.

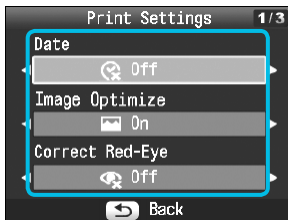

2



### Select the item and change the settings.

- Press the  buttons to select an item.
- Press the  buttons to change the settings, then press the  button to complete the setting.
- Pressing the  button again will restore the image display screen.
- Refer to pp. 18 – 21 for information about each setting.

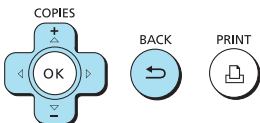

3

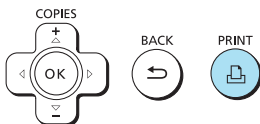

### Print.

- Select an image for printing (p. 13) and the number of copies (p. 13), then press the  button to print.

## Printing With the Date (Date)



- You can print the shooting date recorded by the digital camera.
- Off (Default setting) / On

08/08/2010



- Turning off SELPHY will return the setting to Off.
- Since the date printed will be the date the image was recorded by the digital camera, it cannot be changed on SELPHY.
- You can change the style of the printed date in [Date Format] (p. 21).
- The date will not print if Index], ID Photo] or Shuffle] is selected in [Page Layout] (p. 19).

## Getting the Best Results With Auto Correction (Image Optimize)



- SELPHY will automatically correct the image to achieve optimum image quality.
- Off / On (Default setting)



Some images may not be adjusted correctly.



- Turning off SELPHY will return the setting to On.
- When [Page Layout] (p. 19) is set to Index], [Image Optimize] will not be applied.
- The level of correction will change depending on the page layout and paper size.

## Correcting Red Eyes and Printing (Correct Red-Eye)

- Correct images with red-eye.
- Off (Default setting) / On



Portions other than the eyes may be mistakenly corrected. Set [Correct Red-Eye] to On only when printing images with red-eye.



- If SELPHY is turned off or the memory card is removed, the setting will return to Off.
- Red-eye may not be automatically detected or optimally corrected when faces appear extremely small, large, dark or bright in relation to the overall image, with faces turned to the side or diagonally, or faces with a portion hidden.
- Red-eye correction is not available if 2-up], 4-up], 8-up], or Index] is selected in [Page Layout] (p. 19).
- When Sepia] or B/W] is selected in [My Colors] (p. 20), red-eye correction will not be applied.
- The level of correction will change depending on the page layout and paper size.

## Selecting a Layout and Printing (Page Layout)



- You can set the number of images that you want to print on one sheet. The number of images that you specified (p. 13) will be printed in the selected layout.

<input type="checkbox"/> 1-up (Default setting)	Prints one image using a full sheet	Index	Prints as an index
<input type="checkbox"/> 2-up	Prints two images on one sheet	ID Photo	Prints ID photos on one sheet
<input type="checkbox"/> 4-up	Prints four images on one sheet	Shuffle	Automatically arranges images in a variety of sizes for printing on a single sheet (p. 20)
<input type="checkbox"/> 8-up*	Prints eight images on one sheet		

\* Set the layout to 8-up] when using Color Ink Cassette/Label Set KC-18IL (8-label sheet) (p. 2).



- The settings will be retained even if SELPHY is turned off or the memory card is removed from the slot.
- The image position cannot be specified.
- Depending on the selected layout, the settings made in [Date] (p. 18), [Image Optimize] (p. 18), [Correct Red-Eye] (p. 18), [Borders] (p. 20), [Smooth Skin] (p. 21), or [Brightness] (p. 21) may not be applied.
- If you select [Print All Images] (p. 15) in Index], you can print all images on a memory card as an index print.

## Printing an ID Photo (ID Photo)

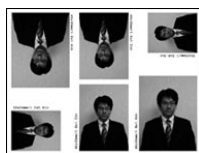

- Prints two ID photos each in three different sizes for a total of six photos on a single sheet, as shown in the picture at the left.
- Prints can be made on L size or Postcard size paper (p. 2).

Paper	Picture Size		
L Size	45 x 35 mm (1.8 x 1.4 in.)	40 x 30 mm (1.6 x 1.2 in.)	30 x 24 mm (1.2 x 0.9 in.)
Postcard Size	60 x 51 mm (2.4 x 2.0 in.)	45 x 35 mm (1.8 x 1.4 in.)	40 x 30 mm (1.6 x 1.2 in.)



The ID photo may not be accepted officially, depending on the institution the ID photo is required for. Please contact the appropriate institution for details.

## Arranging Images of Different Sizes (Shuffle)

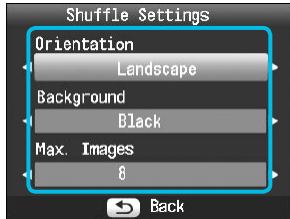

- Shuffle automatically arranges images in a variety of sizes for printing.
- A group of up to 8 images, or a group of up to 20 images can be printed on a single sheet.
- Prints can be made on L size or Postcard size paper (p. 2).
- In "Making Settings" (p. 17), press the ▲▼ buttons to select [Page Layout] in the screen in Step 2. Press the ◀▶ buttons to select [Shuffle], then press the **OK** button.
- When the screen shown on the left appears, press the ▲▼ buttons to select an option.
- Press the ◀▶ buttons to change the settings, then press the ↵ button to complete the setting.
- Pressing the ↵ button twice will restore the image display screen.



- The image position cannot be specified.
- If you select [20] in [Max. Images], it may take some time before images start printing.

## Printing With or Without a Border (Borders)



- You can set images to print with or without a border.
- Borderless (Default setting) /  Bordered



- Turning off SELPHY will return the setting to  Borderless].
- If you select [8-up] when printing on card sized paper (p. 2), images will be printed without borders, even if  Bordered] is selected in [Page Layout] (p. 19).

## Changing the Color Tone and Printing (My Colors)





- You can adjust the colors in your images, or make your images sepia-toned or black and white.

Off (Default setting)	—	Positive Film	Intense, natural colors like those obtained with positive film
Vivid	Emphasizes the contrast and color saturation for a vivid impression	Sepia	Changes the image to sepia tone
Neutral	Tones down the contrast and color saturation for neutral hues	B/W	Black and white





- Turning off SELPHY will return the setting to Off].
- Depending on the settings made in My Colors, [Correct Red-Eye] (p. 18) settings may not be applied.

## Making Skin Look Smooth in Prints (Smooth Skin)

- Makes skin look smooth and beautiful in prints.
-  Off (Default setting) /  On



- When printing is finished, turning off SELPHY and removing the memory card will return the setting to [ Off].
- Correction may be applied to areas other than skin, producing unexpected results.
- When [Page Layout] (p. 19) is set to  Index], [Smooth Skin] will not be applied.

## Adjusting the Brightness (Brightness)



- You can adjust the brightness of an image within a range of  $\pm 3$ .
- The larger the + value, the brighter the image gets. The larger the - value, the darker the image gets.



- Turning off SELPHY will return the setting to [0].
- [Brightness] is not available if  Index] is selected in [Page Layout] (p. 19).

## Changing the Date Format (Date Format)



- You can change the order of the printed date (p. 18).
- mm/dd/yy (Default Setting), dd/mm/yy, yy/mm/dd

08/08/2010

2010/08/08



The setting will be retained even if SELPHY is turned off or the memory card is removed from the slot.

# Printing From Your Computer

If you connect your computer to SELPHY and use the supplied software, you can view all images at once and take advantage of various printing functions that cannot be done with just SELPHY alone. Following the audio guidance will allow inexperienced computer users to print easily.



## Select favorite images from the index and print

- You can select images you wish to print from an index, and print them all at once.



## Print with decorations

- You can add frames or stamps to your images and print. You can also add text to your images and print.



## Print calendars

- You can add calendars to your prints.

## System Requirements

	Windows	Macintosh
OS	Windows 7 Windows Vista Service Pack 1, Service Pack 2 Windows XP Service Pack 3	Mac OS X v10.4 – v10.6
Configuration	The above OS should be pre-installed on computers with built-in USB ports.	
CPU	Pentium 1.3 GHz or higher	PowerPC G4/G5 or Intel Processor
RAM	Windows 7 (64 bit): 2 GB or more Windows 7 (32 bit), Vista (64 bit, 32 bit): 1 GB or more Windows XP: 512 MB or more	Mac OS X v10.4 – v10.5: 512 MB or more Mac OS X v10.6: 1 GB or more
Interface	USB	
Free Hard Disk Space	120 MB or more*	140 MB or more
Display	1,024 x 768 pixels or more	1,024 x 768 pixels or more

\* For Windows XP, Microsoft .NET Framework 2.0 (max. 280 MB) must be installed. Installation may take some time depending on your computer's capabilities.

# Installing and Starting the Software

Windows Vista and Mac OS X 10.5 are used for these explanations.

## Items to Prepare

- Computer
- Supplied CD-ROM (COMPACT PHOTO PRINTER Solution Disk) (p. 2)
- A commercially available USB Cable shorter than 2.5 m (8.2 ft.) (SELPHY terminal requires a Type B connector).

1



2

## Install the software.

### Windows

- Place the CD-ROM in the computer's CD-ROM drive and click [Easy Installation] when the screen on the left appears.
- Follow the on-screen instructions to proceed.
- If the User Account Control window appears, follow the on-screen instructions to proceed.

▶ Proceed with the installation to display the screen on the left.

### Macintosh

- Place the CD-ROM in the computer's CD-ROM drive and double-click .
- When the screen on the left appears, click [Install] and follow the onscreen instructions to proceed.
- When the installation finishes, click [Finish] to restart the computer and complete the installation.

## Prepare SELPHY.

- Turn off SELPHY and remove the memory card or USB flash memory.
- Insert an ink cassette and a paper cassette that contains paper into SELPHY (pp. 8 – 10).

3

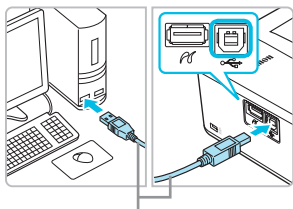

Commercially available USB cable

### Connect SELPHY to the computer.

- Use the USB cable to connect SELPHY to the computer.
- Refer to the user guide included with the cable or computer for handling instructions.

4

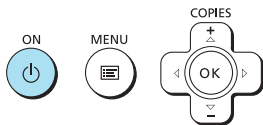

### Turn on SELPHY.

- Press the button to turn on SELPHY.

#### Windows

- When the installation finishes, click [Restart] to restart the computer and complete the installation.

5



### Confirm that the software has been started properly.

- ▶ The software will start and the screen on the left will appear when a connection between SELPHY and the computer is established.
- Perform Steps 2 to 4 to automatically start the software the next time you want to use it.

#### Windows

- If the screen in Step 5 does not appear, open it from the [Start] menu ▶ [All Programs] ▶ [Canon Utilities] ▶ [SELPHY Photo Print] ▶ [SELPHY Photo Print].

#### Macintosh

- If the screen in Step 5 does not appear, follow the procedure below to register your printer. After clicking [ ] in the menu, click [System Preferences], then [Print & Fax] to open the [Print & Fax] window. Click [+] to select [CP800] from the pop-up window, then click [Add]. After you have finished registering your printer, click [SELPHY Photo Print] from the Dock (the bar at the bottom of the desktop), and the screen in Step 5 will appear.



- SELPHY may not operate correctly if it is connected to a computer via a USB hub.
- SELPHY may not function properly if other USB devices (with the exception of a USB mouse or USB keyboard) are used at the same time. Disconnect any other USB devices from your computer and then reconnect SELPHY.
- Do not put your computer into standby mode (or sleep mode) while SELPHY is connected to the computer's USB port. If you accidentally do so, awaken the computer from standby mode without disconnecting the USB cable.
- For details on how to awaken the computer, refer to the user guide included with your computer.



# Using the Software to Print

Use the installed software (SELPHY Photo Print) to print images from your computer. The [Simple print] feature will be explained in this section. Using this feature, you can view all your images at once and select which ones you want to print. If your computer is equipped with speakers, set the volume so that the audio guidance for necessary operations can be heard.

1



## Display the print menu.

- Click [Print menu].
- If printing preparations are not complete (paper cassette and ink cassette inserted), you cannot click [Print menu]. Follow the audio guidance or onscreen instructions to perform the necessary operations.

2

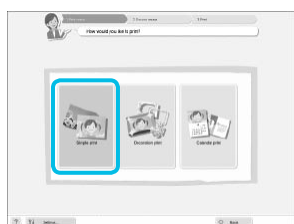

## Select a print method.

- Click [Simple print].
- You can make prints with frames, stamps, and speech bubbles by clicking [Decoration print].
- You can make prints with calendars added by clicking [Calendar print].

3

You can select the conditions for images to display.

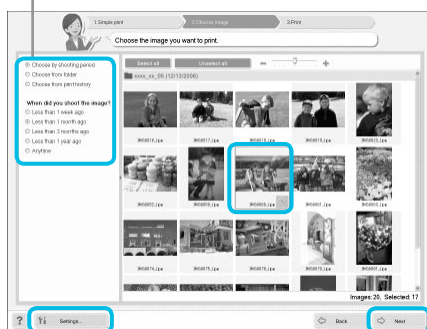

## Select an image.

- ▶ Images will display in an index within the [My Pictures] folder in Windows, and the [Pictures] folder in Macintosh.
- Click an image to select for printing.
- ▶ The background color changes and the image is set for printing.
- Use the same procedure to click all images you want to print.
- If you click an image again, the background color switches back to the original color and the settings are canceled.
- Select an image, then click [Next].

You can display images saved in another folder by pressing this button and selecting a folder from the screen that appears.

4

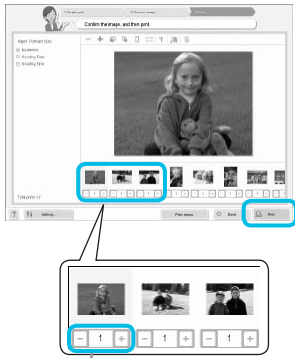

Press the - or + buttons to set the number of prints.

### Select the number of prints.

- Select the number of copies for each image.
- For Windows, click [Print] to start printing.
- For Macintosh, click [Print menu], then click [Print] in the screen that appears.

5

### End the program.

#### Windows

- When all printing is finished, click  at the top right corner of the screen.

#### Macintosh

- When all printing is finished, click  at the top left corner of the screen.



### Turning off Audio Guidance

Audio guidance may not play properly on some computers. If the audio guidance is difficult to hear, follow these steps to turn it off before using the software.

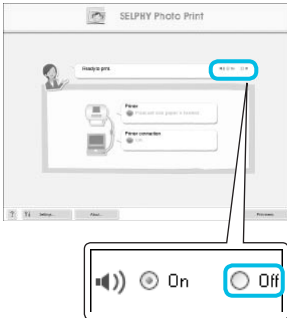

### Turning off Audio Guidance

- While in the screen from Step 1 in "Using the Software to Print" (p. 25), check the [Off] radio button.
- Audio guidance turns off.

# Printing From Your Digital Camera

You can select and print images from a digital camera that supports the PictBridge standard. A Canon brand compact digital camera will be used as an example to explain the print method. If operations are different for the digital camera you use, refer to the user guide included with your digital camera.

1

**Make sure that a memory card is not inserted in SELPHY, and it is not connected to a computer.**

2

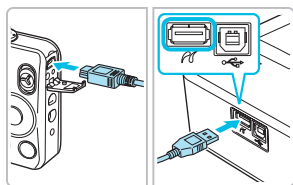

**Connect SELPHY to the digital camera using the interface cable (USB cable) included with the digital camera.**

3

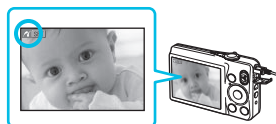

**First turn on SELPHY, then turn on the digital camera and play back the images on the digital camera.**

▶ Depending on the digital camera you use,  may appear on the digital camera's screen.

4

**Perform the necessary operations on your digital camera to select an image for printing.**

- Use the digital camera to start printing.
- ▶ Printing starts.
- After printing has completed, turn off SELPHY and the digital camera, then unplug the cable.



- You cannot stop printing with the  button. Use the digital camera to stop printing.
- PictBridge is an industry standard established by the Camera & Imaging Products Association (CIPA). It allows you to print images taken with any digital camera or video camera, regardless of the manufacturer or model, by connecting to a printer without using a computer.

# Printing Images Using Digital Camera Specified Settings (DPOF Print)

You can make print settings and select images to print on your digital camera and then print the images all at once. For details, refer to the user guide included with your digital camera.

1

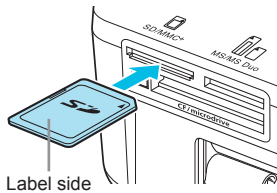

**Insert a memory card containing DPOF settings into the appropriate memory card slot.**

▶ [DPOF images remain Print images?] appears on the screen.



2



**Press the OK button.**

3

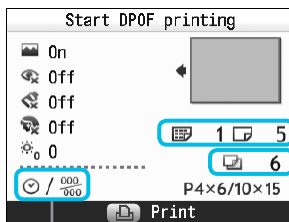

**Check the settings.**

"Print type" set with the digital camera

☰ : Index

☐ : Standard

Number of sheets required

[Date] and [File No.] set with the digital camera

4

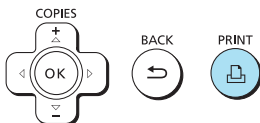

**Print.**

● Press the  button to start printing.

- The date and file number are the DPOF settings made with the digital camera (these settings cannot be changed with SELPHY).
- If, on a Canon brand digital camera, the [Print Type] is set to [Standard], the settings made in "Printing a Variety of Images" (pp. 17 – 21) will be applied.
- The screen in Step 3 can also be displayed when you press the  button and select [DPOF Print], then press the **OK** button. [DPOF Print] only displays when a memory card is inserted that contains DPOF information set with the digital camera.

# Using the Battery Pack

Use the battery pack NB-CP2L (sold separately) for printing images in places without a power outlet. With a fully charged battery, you can print approximately 54 sheets\* of Postcard size paper.

\* The number of possible prints is based on Canon testing standards, and may change depending on printing conditions.

## Installing the Battery

1

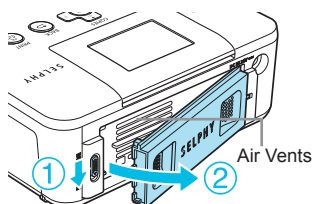

**Remove the battery cover.**

- Slide and hold the cover lock (1), then remove the cover towards (2).

2

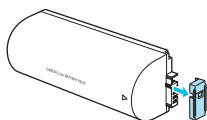

**Remove the battery terminal cover.**

3

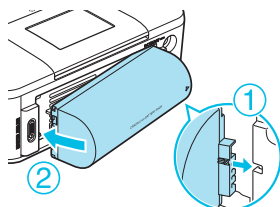



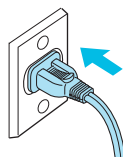

**Attach the battery.**

- Insert the tab (1), then push the battery (2) until it clicks and locks into place.







## Charging the Battery



**Plug in SELPHY (p. 10).**

- ▶ Charging starts and  appears on the screen.
- ▶ Charging completes after approximately 4 hours, and  disappears.
- If you press the  button while the battery is charging (p. 11), SELPHY can be used; however, charging will stop. When you turn SELPHY off (p. 11),  appears and charging resumes.



- For cautions concerning the battery, refer to the user guide included with the battery.
- When  is displayed and you press any button other than the  button for 3 seconds or longer,  will disappear. When the screen is turned off while the battery is charging and you press any button other than the  button,  will appear after approximately 10 seconds.
- If SELPHY is not used for more than five minutes, it will automatically turn off to save power.
- If a red  appears, the battery has reached the end of its life span. Purchase a new battery.

# Printing From Your Mobile Phone

Use the Bluetooth unit BU-30 (sold separately) for wireless printing of images taken with a Bluetooth equipped mobile phone. For details on how to use the mobile phone or on printing methods via Bluetooth refer to the user guide included with the mobile phone.

1

**Make sure that a memory card is not inserted in SELPHY, and it is not connected to a computer.**

2

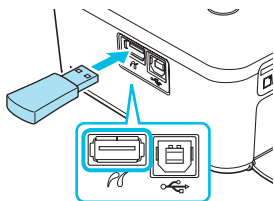

**Insert the Bluetooth unit.**

- Remove the cover attached to BU-30 and insert it as shown.
- Turn on SELPHY (p. 11).

3

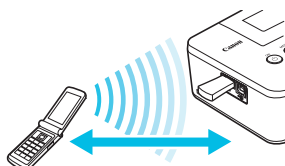

Up to approx. 10 m (33 ft.)

**Transfer images from your mobile phone to SELPHY.**

- The Bluetooth unit blinks blue during data transfer.
- ▶ Printing starts after data transfer is complete.



- During transfer, the blue light on the Bluetooth unit will blink. If transfer is interrupted, the unit will stop blinking. Follow the instructions displayed on your mobile phone and try again.
- The following conditions may cause transfer to slow down or fail, even within a 10 m (33 ft.) range:
  - When there is an obstacle between the Bluetooth unit and the mobile phone
  - When there is electromagnetic interference from magnetic fields, static electricity, or radio waves in the area
- The maximum file size that can be transferred is 2 – 3 MB (varies depending on mobile phone).
- Data transfer time increases when data size is large. Therefore, the amount of time before printing may also increase.
- Depending on the mobile phone model you use, images saved on the memory card may not be printed.
- Depending on the color ink cassette/paper set (p. 2) you use, images may print with the edges cut off.



- Select Canon CP800 (XX:XX:XX) (X stands for one digit) when selecting a target device name on your mobile phone.
- You cannot establish a wireless connection between a computer and SELPHY.
- Movies, e-mail, address book information, or images attached to an e-mail or downloaded from the Internet cannot be printed.
- SELPHY automatically sets the print orientation.

# Troubleshooting

If you think there is a problem with SELPHY, first check the following. If the items below do not solve your problem, contact a Canon Customer Support Help Desk as listed on the included customer support list.

## Power

### ● Power will not turn on

- Make sure the plug is correctly connected (p. 10).
- Hold the  button pressed until the start-up image appears on the screen (p. 11).
- When using a battery (sold separately), use a fully charged battery (p. 29).

## Printing Problems

### ● Cannot print

- Make sure SELPHY is turned on (p. 11).
- Make sure that the ink and paper cassettes are correctly inserted (p. 10).
- When the ink is spent, replace the ink cassette with a new one. When the paper is spent, refill the paper cassette with new paper (p. 14).
- Make sure you are using the correct combination of paper, paper cassette and ink cassette (p. 8).
- Connect SELPHY to only one device at a time. If SELPHY is connected simultaneously to a digital camera, computer and has a memory card inserted, you may not be able to print properly.
- Make sure there is no slack in the ink sheet (p. 8).
- Make sure that you are using dedicated paper (p. 9).
- Depending on the room temperature, SELPHY may overheat and temporarily stop operating. This is not a malfunction. Wait until the temperature drops and printing resumes. If SELPHY is connected to a computer, a message will appear on the computer screen. Do not cancel the print. Wait until printing resumes.

### Cannot display/print images from memory card or USB flash memory

- Make sure the memory card is inserted all the way into the correct slot with the label facing upward (pp. 12, 13).
- Make sure the USB flash memory is inserted all the way, in the correct direction (p. 14).
- Make sure you are using a supported image type (p. 12).
- Make sure that any memory card requiring an adapter is inserted into the adapter before being inserted into the slot (p. 12).

### Printing from digital cameras

- Make sure your digital camera supports PictBridge (p. 27).
- Make sure SELPHY and the digital camera are connected correctly (p. 27).
- Make sure the battery/batteries in your digital camera are not depleted. If there is insufficient charge, replace the battery with a fully charged one, or new batteries.

### Printing from computers

- Make sure you installed the software according to the correct procedure (p. 23).
- Make sure SELPHY is connected directly to a port on the computer with the USB cable (p. 24).
- Problems Exclusive to Windows: Make sure the printer is not set to offline. If it is, right-click the printer icon and cancel the offline setting.
- Problems Exclusive to Macintosh: Make sure SELPHY is registered on the Printer List (p. 24).

### ● Cannot print the date

#### Printing from memory cards or USB flash memory

- Make sure the date imprint option is set (p. 28).  
If you are using DPOF printing, the date imprint settings are configured on the digital camera used for the DPOF settings.

### Printing from mobile phones

- The date cannot be imprinted on images sent from a mobile phone (p. 30).

### Printing from digital cameras

- Make sure the date setting in your digital camera is set to [On]. However, if the setting is [Default], the date imprint settings of SELPHY will be used.

### ● Cannot make clean prints

- Make sure the ink sheet and paper are not dusty.
- Make sure there is no dust stuck on the inside surfaces of SELPHY (p. 34).
- Make sure no condensation has formed on the inside surfaces of SELPHY (p. 34).
- Make sure SELPHY is not placed near a device emitting electromagnetic waves or a strong magnetic field (p. 5).

### ● Colors on the computer display and the print are different

- Color generation methods are different with computer screens and printers. Moreover, the variance may be attributable to the environment in which the screen is viewed (color and strength of the light), or to the screen's color adjustment settings.

### ● After using the computer to cancel a print in progress, an image that had already been printed was printed again when printing resumed

- When you restart printing on a Macintosh computer after canceling, an already printed image may print again when printing resumes.

## Paper Problems

### ● Paper will not fit into cassette

- Make sure the paper size matches the size of the paper cassette (p. 2).

### ● Paper is not feeding properly/frequent paper jams

- Make sure the paper and paper cassette are correctly inserted (pp. 8, 10).
- Make sure there are less than 19 sheets in the cassette.
- Make sure 19 or more sheets have not collected on the outer lid of the paper cassette.
- Make sure that you are using dedicated paper (p. 9).

### ● Cannot print the specified number of prints/paper left over

- Canceling a print in progress or pulling on the ink sheet will consume ink. If paper runs out while printing many images, do not remove the ink cassette, as this will consume ink. Instead, refill the paper without removing the ink cassette.

### ● Paper is jammed

- If the paper is sticking out from the front or back (paper ejection slot) (p. 6) of SELPHY, gently tug on the paper to remove it. However, if a gentle tug is not sufficient to remove the paper, do not attempt to forcibly pull it out. Turn the printer off and on repeatedly until the paper is ejected.

## Error Messages

If a problem occurs with SELPHY, a message appears on the screen. If a possible solution displays with the error message, follow the on-screen instructions. If no solution displays, refer to "Troubleshooting" (p. 31).

If these items do not solve your problem, contact a Canon Customer Support Help Desk as listed on the included customer support list.



If a problem occurs while SELPHY is connected to a digital camera, an error message may appear on screen of the digital camera.



# Specifications

## SELPHY CP800

<b>Printing Method</b>	Dye-sublimation thermal transfer (with overcoating)	
<b>Resolution/Color Representation</b>	300 x 300 dpi YMC (256 shades per color, 16.77 million colors per dot (max)) (Resolution based on the "area intensity method" is equivalent to a 4800 x 4800 dpi color representation)* <sup>1</sup>	
<b>Ink</b>	Dedicated color ink cassette (Y/M/C/overcoating)	
<b>Paper</b>	Postcard Size, L Size, Card Size (including full page label sheets, 8-label sheets)	
<b>Print Size</b>	<b>Borderless</b>	<b>Bordered</b>
Postcard Size	100.0 x 148.0 mm (3.94 x 5.83 in.)	91.4 x 121.9 mm (3.60 x 4.80 in.)
L Size	89.0 x 119.0 mm (3.50 x 4.69 in.)	79.2 x 105.3 mm (3.12 x 4.15 in.)
Card Size (per label)	54.0 x 86.0 mm (2.13 x 3.39 in.) 22.0 x 17.3 mm (0.87 x 0.68 in.)	50.0 x 66.7 mm (1.97 x 2.63 in.)
<b>Printing Speed</b> <sup>2</sup>	<b>Printing from memory cards/USB flash memory/Connected to cameras (PictBridge)</b>	
Postcard Size	Approx. 47 sec.	
L Size	Approx. 39 sec.	
Card Size	Approx. 24 sec.	
<b>Feeding System</b>	Automatic paper feed from paper cassette	
<b>Ejection System</b>	Automatic paper ejection on top of paper cassette	
<b>Screen</b>	Tilt-up, 2.5 type, TFT LCD color Monitor	
<b>Interface</b>		
USB	Connecting to a PictBridge compliant device: USB compliant Type A connector Connecting to a computer: USB compliant Type B connector	
Wireless	Bluetooth* <sup>3</sup>	
Memory Cards	CF (CompactFlash) Card, Microdrive, xD-Picture Card* <sup>4</sup> , SD Memory Card, SDHC Memory Card, SDXC Memory Card, MultiMediaCard, MMCplus Card, HC MMCplus Card, miniSD Memory Card* <sup>4</sup> , miniSDHC Memory Card* <sup>4</sup> , microSD Memory Card* <sup>4</sup> , microSDHC Memory Card* <sup>4</sup> , microSDXC Memory Card* <sup>4</sup> , RS-MMC Card* <sup>4</sup> , MMCmobile Card* <sup>4</sup> , MMCmicro Card, Memory Stick, Memory Stick PRO, Memory Stick Duo, Memory Stick PRO Duo, Memory Stick micro* <sup>4</sup>	
<b>USB Flash Memory</b>	FAT/exFAT only supported	
<b>Operating Temperatures</b>	5 – 40 °C (41 – 104 °F)	
<b>Operating Humidity</b>	20 – 80 %	
<b>Power Source</b>	Compact Power Adapter CA-CP200 W Battery pack NB-CP2L (sold separately)	
<b>Power Consumption</b>	60 W or less (4 W or less on standby)	
<b>Dimensions</b>	177.0 x 134.6 x 68.8 mm (6.97 x 5.30 x 2.71 in.)	
<b>Weight (printer only)</b>	Approx. 940 g (approx. 33.2 oz.)	

\*<sup>1</sup> The "concentration gradation method" used by SELPHY allows 256 shades (max) of color to be represented per dot. In comparison, printers using the area intensity method represent shades by the number of dots printed in a unit of area, i.e. 256 dots (16 dots vertical x 16 dots horizontal) are needed to represent the same 256 shades of color. SELPHY's color representation is therefore equivalent to a 4800 x 4800 dpi resolution based on an area intensity method.

• Gradation refers to the number of shades that can be represented on a print. For example, black and white has two gradations, while 256 gradations include the shades of gray going from white to black that can be represented.

• "dpi" refers to the number of dots that can be printed in 1 inch ("dots per inch").

\*<sup>2</sup> Measured from start of the yellow printing pass to final output.

\*<sup>3</sup> Bluetooth unit BU-30 (sold separately) is required.

\*<sup>4</sup> Dedicated adapter (commercially available) is required.

## Compact Power Adapter CA-CP200 W

Rated Input	100 – 240 V AC (50/60 Hz) 1.5 A (100 V) – 0.75 A (240 V)
Rated Output	24 V DC, 2.2 A
Dimensions	122.0 x 60.0 x 30.5 mm (4.80 x 2.36 x 1.20 in.) (excluding power cord)
Operating Temperatures	0 – 45 °C (32 – 113 °F)
Weight	Approx. 310 g (10.9 oz.)

## Battery Pack NB-CP2L (Sold Separately)

Type	Rechargeable lithium-ion battery
Nominal Voltage	22.2 V DC
Nominal Capacity	1200 mAh
Battery Life (Charge Cycles)	Approx. 300 times
Operating Temperatures	5 – 40 °C (41 – 104 °F)
Dimensions	110.0 x 40.7 x 37.5 mm (4.33 x 1.60 x 1.48 in.)
Weight	Approx. 230 g (8.11 oz.)

- All data is based on tests by Canon.
- Printer specifications or appearance are subject to change without notice.



As an ENERGY STAR Partner, Canon Inc. has determined that this product meets the ENERGY STAR guidelines for energy efficiency.

**CAUTION**  
RISK OF EXPLOSION IF BATTERY IS REPLACED BY AN INCORRECT TYPE.  
DISPOSE OF USED BATTERIES ACCORDING TO LOCAL REGULATION.

## Handling Precautions

- Do not subject the printer to excessive force. Force or impact on the printer may result in paper jams or equipment damage.
- Be careful not to spray the equipment with insecticides or other volatile substances. In addition, do not store the equipment in contact with rubber or vinyl products for long periods of time. This may cause deterioration of the casing.
- Depending on the room temperature, SELPHY may overheat and temporarily stop operating. This is not a malfunction. SELPHY will resume normal printing as soon as it cools down. Temporary stoppages increase printing time and are most likely to occur when printing continuously, if a room is unusually warm, or if the air vents on the back of SELPHY are blocked and internal temperature is high.
- Avoid condensation on SELPHY when moving it from a cold to a warm place by putting it in an airtight, sealable plastic bag and allowing for adjustment to temperature changes gradually before removing from the bag. In the event that condensation does form within SELPHY, keep it at room temperature until the water droplets evaporate naturally before use.
- When SELPHY becomes dirty, wipe the casing with a soft dry cloth.
- When dust or dirt has accumulated on the battery cover or vents (pp. 6, 29), be sure to remove the ink cassette (p. 14) before cleaning. If dust gets in through the vents, the printer may not print cleanly.



Never wipe using volatile solvents such as benzene, paint thinner, or diluted neutral solvent. They may cause deformation or peeling of the casing.



USA and Canada only:

The Lithium ion/polymer battery is recyclable.

Please call 1-800-8-BATTERY for information on how to recycle this battery.

## FCC Notice

(Printer, Model CD1085, CD1093 Systems)

This device complies with part 15 of the FCC Rules. Operation is subject to the following two conditions:

- (1) This device may not cause harmful interference, and
- (2) this device must accept any interference received, including interference that may cause undesired operation.

NOTE: This equipment has been tested and found to comply with the limits for a Class B digital device, pursuant to part 15 of the FCC Rules. These limits are designed to provide reasonable protection against harmful interference in a residential installation.

This equipment generates, uses and can radiate radio frequency energy and, if not installed and used in accordance with the instructions, may cause harmful interference to radio communications. However, there is no guarantee that interference will not occur in a particular installation. If this equipment does cause harmful interference to radio or television reception, which can be determined by turning the equipment off and on, the user is encouraged to try to correct the interference by one or more of the following measures:

- Reorient or relocate the receiving antenna.
- Increase the separation between the equipment and receiver.
- Connect the equipment into an outlet on a circuit different from that to which the receiver is connected.
- Consult the dealer or an experienced radio/TV technician for help.

The cable with the ferrite core provided with the printer must be used with this equipment in order to comply with Class B limits in Subpart B of Part 15 of the FCC rules.

Do not make any changes or modifications to the equipment unless otherwise specified in the manual. If such changes or modifications should be made, you could be required to stop operation of the equipment.

### Canon U.S.A., Inc.

One Canon Plaza, Lake Success, NY 11042, U.S.A.

Tel No. (516) 328-5600

## Canadian Radio Interference Regulations

This Class B digital apparatus complies with Canadian ICES-003.

## Trademark Acknowledgments

- SDXC Logo is a trademark of SD-3C, LLC.
- This device incorporates exFAT technology licensed from Microsoft.
- Portions of the code used in this firmware are based in part on the work of the Independent JPEG Group.

## About This Guide

- Reprinting, transmitting, or storing in a retrieval system any part of this guide without the permission of Canon is prohibited.
- Canon reserves the right to change the contents of this guide at any time without prior notice.
- Illustrations and screenshots in this guide may differ slightly from the actual equipment.
- The above items notwithstanding, Canon accepts no liability for damages due to mistaken operation of the products.

This product is designed to achieve excellent performance when used with genuine Canon accessories. Canon shall not be liable for any damage to this product and/or accidents such as fire, etc., caused by the malfunction of non-genuine Canon accessories (e.g., a leakage and/or explosion of a battery pack). Please note that this warranty does not apply to repairs arising out of the malfunction of non-genuine Canon accessories, although you may request such repairs on a chargeable basis.